

POST FOUNDATION PLAN
SCALE - 1/2" = 0' 1" = 2"

NOTE:
SEE SHEET 4 FOR ALTERNATE
MASONRY FOUNDATION.

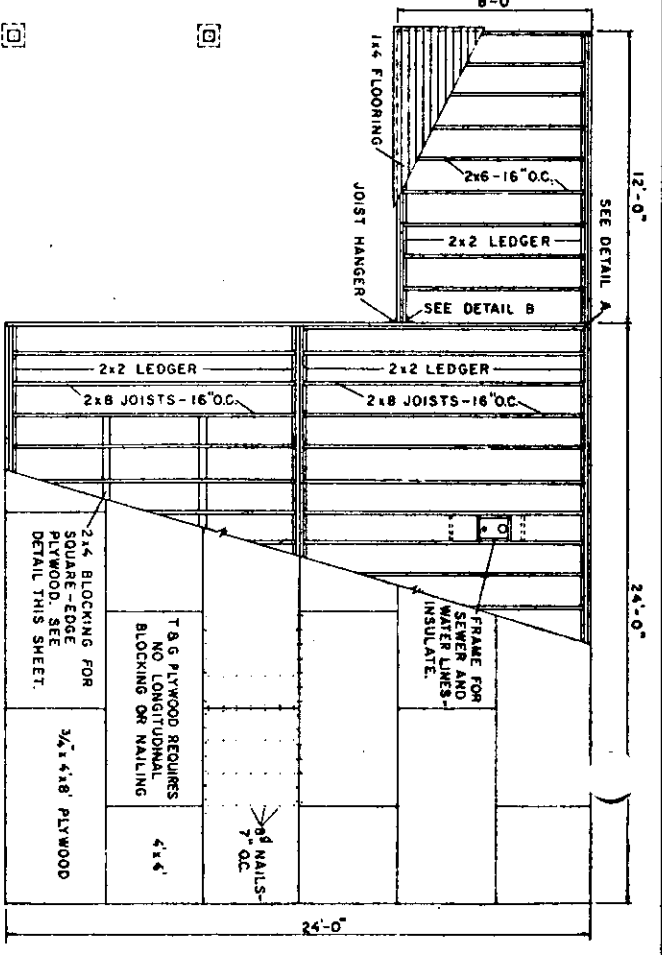

FLOOR FRAMING PLAN
SCALE - 1/2" = 0' 1" = 2"

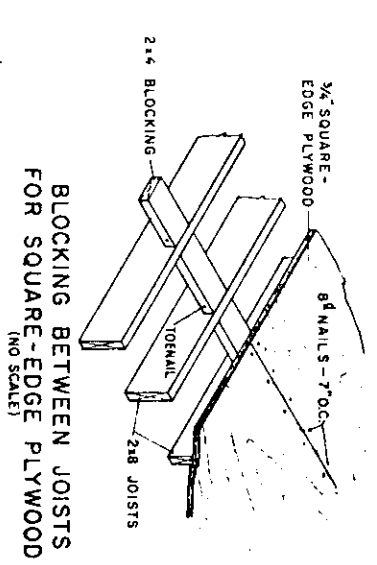
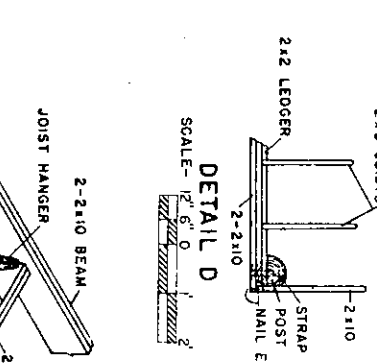
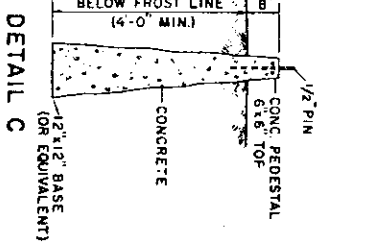
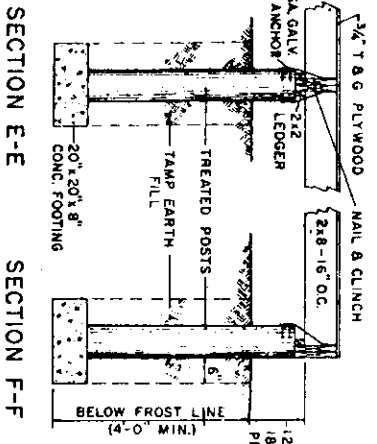

BLOCKING BETWEEN JOISTS FOR SQUARE-EDGE PLYWOOD
(NO SCALE)

POURCH DETAILS
(NO SCALE)

DESIGNED BY:
FOREST PRODUCTS LABORATORY
MADISON, WISCONSIN
FS-FPL 3

COOPERATIVE EXTENSION WORK IN
AGRICULTURE AND HOME ECONOMICS

UNITED STATES DEPARTMENT OF AGRICULTURE COOPERATING
AND
TWO BEDROOM HOUSE
FRAME CONSTRUCTION

USDA 70 7187 SHEET 1 OF 4

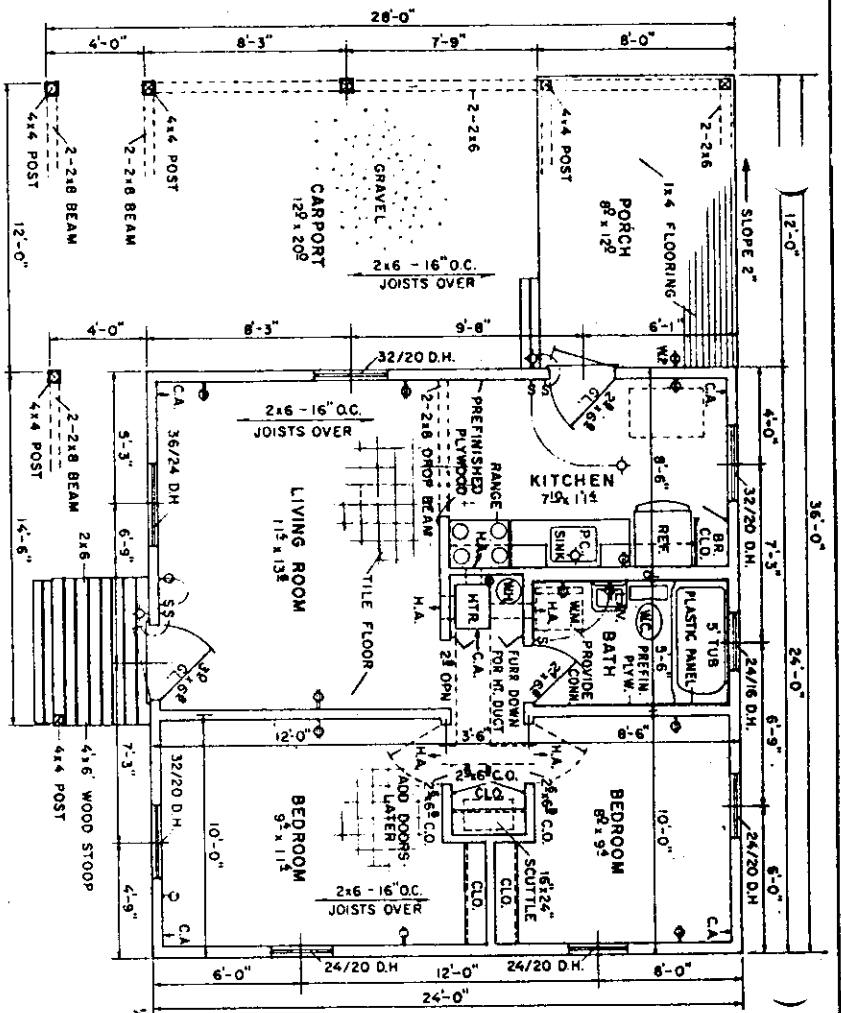

FLOOR PLAN
SCALE - 1/8" = 1'-0"

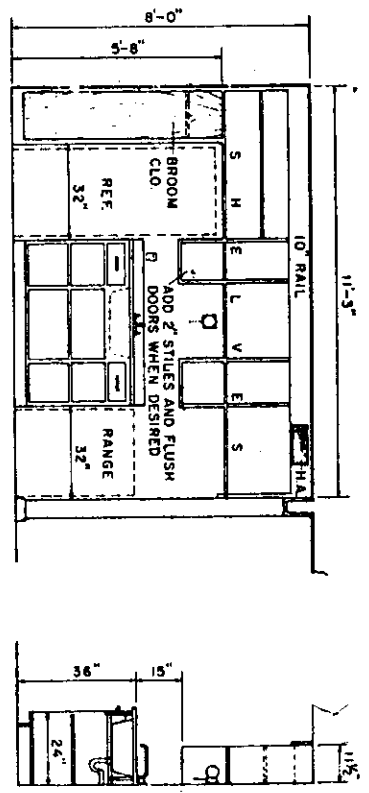

KITCHEN CABINETS
SCALE - 1/8" = 1'-0"

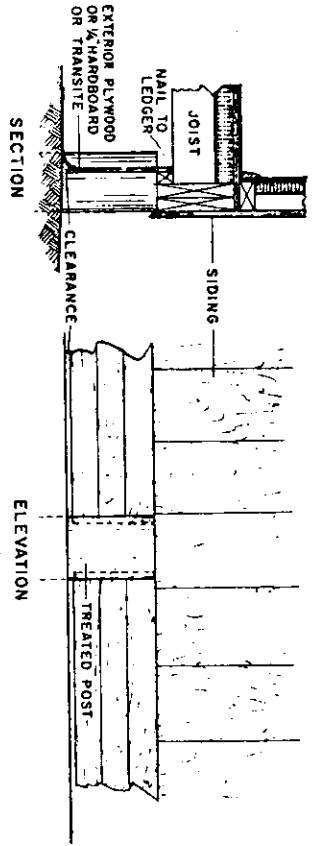

SKIRTBOARD DETAIL
SCALE - 1/2" = 1'-0"

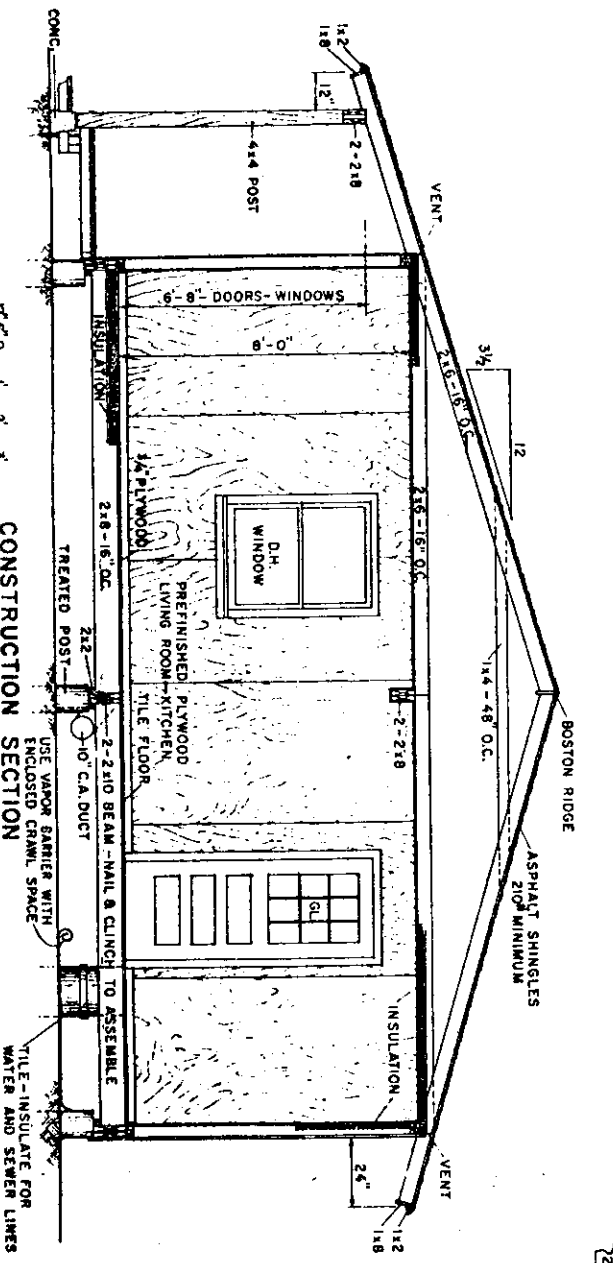

CONSTRUCTION SECTION
SCALE - 1/8" = 1'-0"

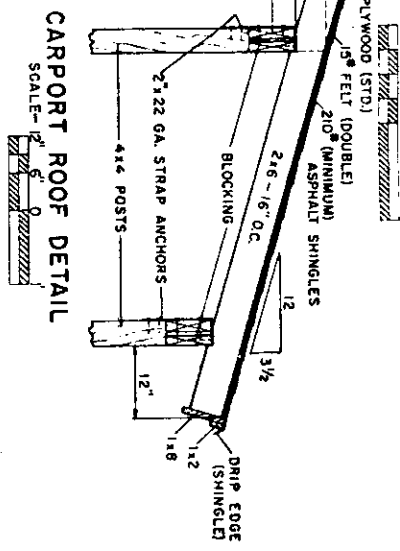

CARPENT ROOF DETAIL
SCALE - 1/2" = 1'-0"

COOPERATIVE EXTENSION WORK IN
AGRICULTURE AND HOME ECONOMICS

UNITED STATES DEPARTMENT OF AGRICULTURE COOPERATING
AND
NATIONAL ASSOCIATION OF HOME ECONOMICS

TWO BEDROOM HOUSE
FRAME CONSTRUCTION

USDA 70 7187 SHEET 2 OF 4

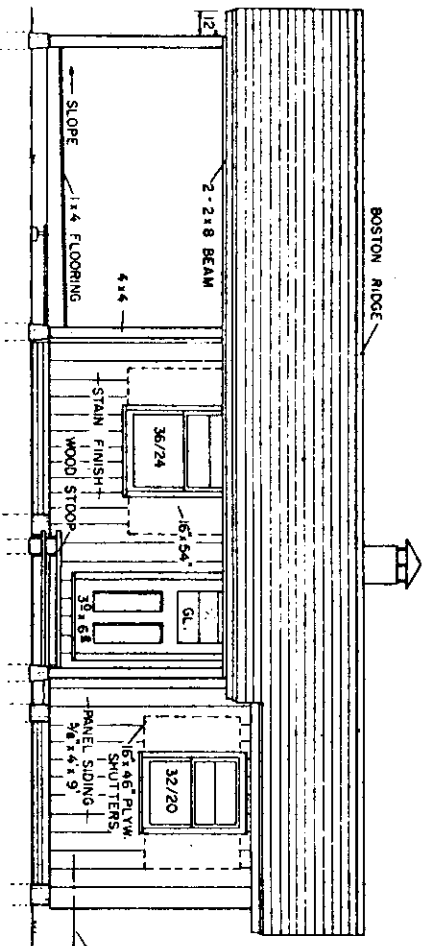

FRONT ELEVATION

SCALE - 1/2" = 1'-0"

FINISHING :
SIDING AND TRIM - PIGMENTED
STAIN, USE CONTRASTING
COMPLEMENTARY COLORS.
WINDOWS AND DOORS - PAINT.
(SAME COLOR AS TRIM)

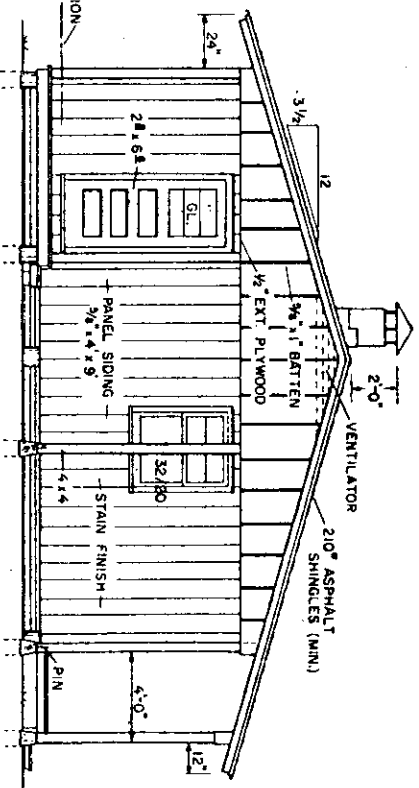

LEFT END ELEVATION

SCALE - 1/2" = 1'-0"

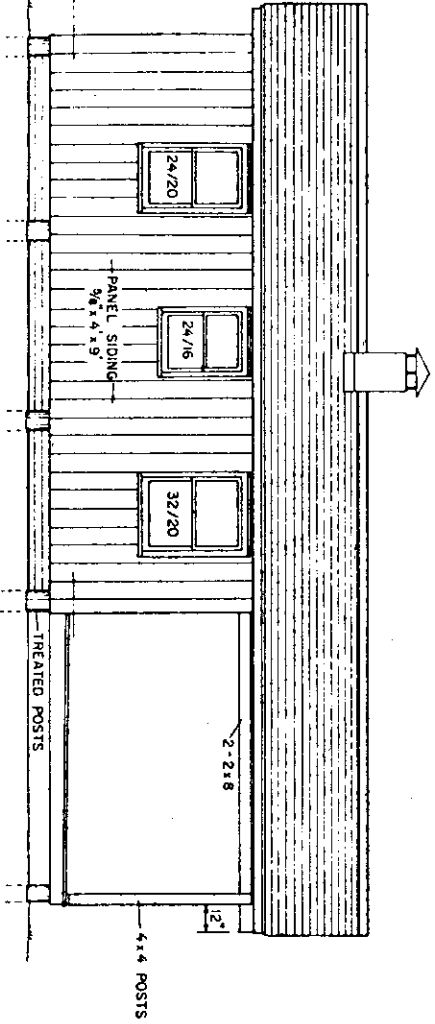

REAR ELEVATION

SCALE - 1/2" = 1'-0"

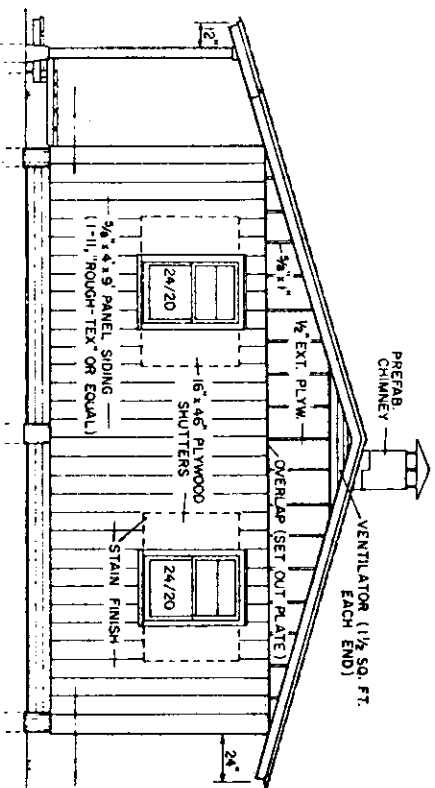

RIGHT END ELEVATION

SCALE - 1/2" = 1'-0"

COOPERATIVE EXTENSION WORK IN
AGRICULTURE AND HOME ECONOMICS

UNITED STATES DEPARTMENT OF AGRICULTURE
AND
COOPERATING

TWO BEDROOM HOUSE
FRAME CONSTRUCTION
USDA - '70 7187 SHEET 3 OF 4

